





BF-F8HP-PRO

INSTRUCTION MANUAL

Thank you for purchasing the BF-F8HP PRO Amateur Radio. This dual-band, dual-display, dual-watch radio offers easy operation and ensures secure, instant, and reliable communications at peak efficiency. Please read this manual carefully before use to achieve maximum performance from your radio.

 **WARNING: Modifying this device to receive cellular radiotelephone signals is prohibited by FCC rules and federal law.**

 **ATTENTION!** When programming the radio, start by reading the factory software data. Then, save this data with your frequencies and other settings to a new code plug to avoid errors. Use the programming cable and a PC to set the authorized frequency, bandwidth, power, etc. Ensure your programming complies with your FCC (or EU) license certification.

 **ATTENTION!** Before using this product, read the RF Energy Exposure and Product Safety Guide included with the radio. It contains important safety instructions and information on RF energy awareness and control to ensure compliance with applicable standards and regulations.

 **FRS, GMRS, MURS, PMR446**
Although you might want to use FRS, GMRS, MURS (in the USA), or PMR446 (in Europe) frequencies, please be aware that restrictions on these bands make it illegal to use this transceiver on them.

TABLE OF CONTENTS

Regulations and Safety Warnings	4
Contents	8
Features and Functions	9
Battery Information	10
Installing/Removing Battery and Antenna	13
Radio Overview	15
Basic Operations	19
Advanced Features	26
Main Menu Functions	38
Appendix A — Troubleshooting Guide	41
Appendix B — Technical Specs	43
Appendix C — Shortcut Menu Operations	45
Appendix D — DCS Table	67
Appendix E — CTCSS Table	69

Regulations and Safety Warnings

FCC Regulatory Conformance

This equipment has been tested and found to comply with the limits for a Class B digital device under Part 15 of FCC Rules. These limits aim to provide reasonable protection against harmful interference in a residential installation. This equipment generates and can radiate radio frequency energy, which, if not installed and used according to the instructions, may cause harmful interference to radio communications. However, there is no guarantee that interference will not occur in a particular installation. If this equipment does cause harmful interference to radio or television reception, the user can try to correct the interference by:

- *Reorienting or relocating the receiving antenna.*
- *Increasing the separation between the equipment and receiver.*
- *Connecting the equipment into an outlet on a different circuit than the receiver is connected.*
- *Consulting the dealer or an experienced radio/TV technician for help.*
- *Changes or modifications not expressly approved by the party responsible for compliance could void the user's authority to operate the equipment.*

This device complies with Part 15 of the FCC Rules. Operation is subject to the condition that this device does not cause harmful interference.



WARNING: *Modifying this device to receive cellular radiotelephone signals is prohibited by FCC rules and federal law.*

Compliance with RF Exposure Standards

The radio complies with the following RF energy exposure standards and guidelines:

- United States Federal Communications Commission Code of Federal Regulations; 47 CFR § 1.1307, 1.1310, and 2.1093
- American National Standards Institute (ANSI) / Institute of Electrical and Electronic Engineers (IEEE) C95.1:2005; Canada RSS102 Issue 5 March 2015
- Institute of Electrical and Electronic Engineers (IEEE) C95.1:2005 Edition

RF Exposure Compliance and Control Guidelines and Operating Instructions

To control your exposure and ensure compliance with the occupational/controlled environmental exposure limits, always adhere to the following procedures:

Guidelines

- Do not remove the RF Exposure Label from the device.
- User awareness instructions should accompany the device when transferred to other users.
- Do not use this device if the operational requirements described herein are not met.

Operating Instructions

- Transmit no more than the rated duty factor of 50% of the time. To transmit (talk), press the Push-to-Talk (PTT) key. To receive calls, release the PTT key. Transmitting 50% of the time or less is important because the radio generates measurable RF energy only when transmitting.
- Keep the radio unit at least 2.5 cm away from the face. The antenna should be kept away from the face and eyes.
- When worn on the body, always place the radio in an approved holder, holster, case, or body harness, or use the correct clip for this

product. Use of non-approved accessories may result in exposure levels that exceed the FCC's occupational/controlled environmental RF exposure limits.

- Use of non-approved antennas, batteries, and accessories may cause the radio to exceed the FCC RF exposure guidelines.

Precautions for Portable Two-Way Radios

Operating Prohibitions

To prevent property loss, injury, or death, follow these safety instructions:

- Do not use the product in areas with fuels, chemicals, explosive environment, or other flammable materials. Only use an approved Ex-protection model in such locations. Do not assemble or disassemble it.
- Do not use the product near or in blasting areas.
- Do not use the product near medical or electronic equipment sensitive to RF signals.
- Do not hold the product while driving.
- Do not use the product in areas where wireless communication equipment is prohibited.

Important Tips

To use the product effectively, follow these guidelines:

- Do not use unauthorized or damaged accessories.
- Keep the product at least 2.5 centimeters away from your body during transmission.
- Do not use the product at high volume for extended periods.
- In vehicles with airbags, do not place the product over or near the airbag deployment area.
- Keep the product and its accessories out of reach of children and pets.
- Operate the product within the specified temperature range.
- Continuous transmission may cause the product to heat up. Let it cool in a proper location.
- Handle the product with care.

- Do not disassemble, modify, or repair the product or its accessories without authorization.

Precautions for Batteries

Charging Prohibitions

To prevent property loss, injury, or death, follow these safety instructions:

- Do not charge or replace the battery in areas with fuels, chemicals, explosive atmospheres, or other flammable materials.
- Do not charge a wet battery. Dry it with a soft, clean cloth before charging.
- Do not charge a deformed, leaking, or overheated battery.
- Do not use an unauthorized charger.
- Do not charge the battery in areas with strong radiation.
- Do not overcharge the battery, as it may shorten its life.

Maintenance Instructions

To ensure normal operation and prolong battery life:

- Clean the charging connector regularly with a clean, dry cloth.
- Charge the battery at temperatures between 5° and 40° to avoid reducing battery life or causing leakage.
- Turn off the product before charging the attached battery to ensure a full charge.
- Do not remove the battery or unplug the power cord during charging.
- Do not dispose of the battery in fire.
- Do not expose the battery to direct sunlight for long periods or place it near heat sources.
- Do not squeeze, puncture, or remove the battery housing.

Transportation Instructions

- Do not transport damaged batteries.
- To avoid short circuits, separate batteries from metal parts or each other if transporting multiple batteries in one package.

—Turn off and secure the radio against accidental activation if the battery is attached.

Declare the shipment contents in the shipping documents and use a Battery Shipping Label on the packaging. Contact your hauler for local regulations and further information.

Contents

The box contains the following items:

- Radio body
- Lithium-Ion battery pack
- Belt Clip
- 2 Antennas:
 - V85 Antenna — preferred 144/440MHz antenna*
 - V21 Flex Antenna — preferred wideband receiver antenna*
- Desk charger (with wall adapter)
- Earpiece Kit
- Wrist Belt
- Instruction Manual

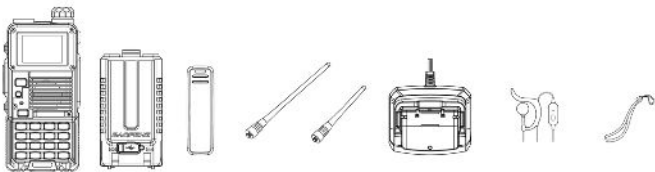

Features and Functions

- **1.77" TFT Large Screen**
- **Multiple Scan Functions:** Includes VFO scan range setting and three scan methods: channel scan, CTC/DCS scan, and the ability to add or remove channels from the scan list.
- **Multiband Scanning Receiver:** Covers 108-136, 136-174, 220-260, 350-390, 400-520 MHz
- **Built-in Input Method:** Allows easy editing of channel names.
- **NOAA Weather Radio:** Receives weather radio channels in the United States and Canada.
- **Selectable Frequency Steps:** Choose from 2.5K, 5.0K, 6.25K, 10.0K, 12.5K, 20.0K, 25.0K, and 50.0K.
- **Convenient Charging:** Features Type-C direct charging and charging dock
- **Tri-Band Handheld Transceiver**
- **DTMF Encoder and Manual Dial**
- **High-Capacity Lithium-Ion Battery**
- **Broadcast FM Radio**
Receiver: Covers 65-75MHz and 78-108 MHz
- **50 CTCSS Tones and 105 DCS Code Defaults:** Allows custom CTCSS tone entry.
- **VOX** (Voice-Activated Transmit)
- **Storage:** Up to 10 zones and 1000 named memory channels.
- **Alarm Function**
- **Power Options:** Selectable high, medium, or low transmit power.
- **Programmable Display Illumination:** Adjustable via keypad.
- **Function Beep on the Keyboard**
- **Dual Watch/Dual Reception:** Single watch mode option well.
- **Programmable Repeater Offset**
- **Battery Saving Function**
- **Transmission Time-Out Timer**
- **Busy Channel Lock Out**
- **Squelch Adjustment:** Ten levels of squelch adjustment.
- **End of Transmission Tone** ("Roger Beep")
- **Dual Independent Zone Monitoring**
- **Built-in Stopwatch function**
- **One Touch Search**
- **Frequency/Frequency Clone**
- **'K1' 2-Pin Kenwood Accessory Jack**
- **PC Programmable**
- **GPS Positioning Function:** For location sharing and requesting location information.

Battery Information

Charging the Battery Pack

The Li-ion battery pack is not charged at the factory, so please charge it before use. Charging the battery for the first time or after extended storage (over 2 months) may not bring it to its full capacity. Fully charge and discharge the battery two or three times to achieve the best performance. If the battery life decreases significantly, replace the battery pack.

Charger Supplied

Use only the charger provided by BTECH. Other chargers may cause explosions or injury. If the radio displays a low battery warning with a red flashing light or voice prompt, charge the battery.

Use Caution with the Li-ion Battery

- Do not short the battery terminals or throw the battery into a fire.
- Do not remove the casing from the battery pack.
- Charge the battery at temperatures between 5°C – 40°C (40°F – 105°). Charging outside this range may not fully charge the battery.
- Turn off the radio before inserting it into the charger to ensure proper charging.
- Do not cut off the power or remove the battery during charging until the green light is on.
- Do not recharge a fully charged battery to avoid shortening its life or causing damage.
- Do not charge a damp battery; dry it before charging.



Keep the battery terminals away from metal objects like keys or chains, as they can short circuit the battery, causing heat and potential injury. Use an insulated container to carry the battery.

How to Charge

1. Plug the AC adapter into an AC outlet and connect the cable to the DC jack on the back of the charger. The indicator light will blink orange, indicating it is ready to charge.
2. Insert the battery or the radio into the charger, ensuring good contact with the charging terminals. The indicator light will turn red to indicate charging.
3. It takes approximately 2–5 hours to fully charge the battery. When the lamp turns green, charging is complete. Remove the battery or radio from the charger.



If the radio is on during charging, the lamp will not turn green to show the fully charged status. The radio must be off for the charger to indicate correct battery status.

LED Indicator

Red LED	Green LED	Status
Flashing	Steady	Standby (charger empty) Error (charger with radio)
Steady	Off	Charging
Off	Steady	Charging Complete



The charger and battery have matching notches so you can charge the battery on its own, which is practical if you have two batteries. This way, you can charge one battery while still using your radio. The radio should be turned off during the charge cycle.

Using the Type-C Charger

The Type-C charger is a handy port that allows you to conveniently charge your Li-on battery pack.

- Turn off the radio.
- Plug the Type-C cable into the Type-C charging port on the battery. Connect the other end to a compatible USB-C outlet.
- An empty battery will fully charge in about 6 hours.
- The battery meter on the LCD will indicate charging.

Battery Maintenance

- Charge the battery for at least 4–5 hours before first use.
- Use only approved batteries.
- Do not disassemble the battery pack.
- Do not expose batteries to fire or intense heat.
- Dispose of batteries according to local recycling regulations. Do not throw them in the trash.

Prolonging the life of your battery

- Charge batteries at normal room temperatures.
- Turn off the radio while charging for faster results.
- Do not unplug the charger or remove the battery/radio before charging is complete.
- Never charge a wet battery.
- Replace the battery if you notice a significantly shorter operating time.
- Battery performance decreases in cold temperatures. Keep a spare battery warm in cold environments.
- Clean battery contacts with a clean cloth if necessary.



If your battery gets wet, remove it from the radio, dry it with a towel, and place it in a plastic bag with dry rice overnight to absorb moisture. This method works for minor splashes but may not save a soaked radio.

How to Store the Battery

- Store the battery at 80% discharge.
- Keep it in a cool, dry place away from direct sunlight.
- Cycle the battery every six months to avoid severe capacity degradation.



- Do not short circuit the battery terminals.
- Do not remove the battery casing.
- Store the battery in safe surroundings to avoid short circuits and explosions.
- Do not expose the battery to heat or fire.

Installing/Removing Battery and Antenna

Installing the Battery Pack

1. Turn off the radio by turning the power/volume knob counterclockwise until it clicks off.
2. Align the battery parallel with the radio body, with the lower edge of the battery about 1 to 2 cm below the edge of the radio.
3. Slide the battery upward along the guide rails until you hear a click, indicating it is locked in place.



Removing the Battery Pack from Radio

1. Ensure the radio is turned off.
2. Press the battery release button above the battery pack.
3. Slide the battery downward to remove it.



Installing the Antenna

1. Align the Male SMA connector on the transceiver with the Female SMA connector on the antenna.
2. Turn the antenna clockwise until it is securely attached.

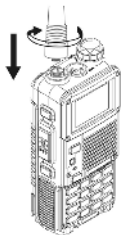

Removing the Antenna

1. Turn the antenna counterclockwise until it is detached from the transceiver.

Note: Two antennas are included for optional use.

Installing / Removing the Belt Clip

1. Remove the two parallel screws located above the battery on the back of the radio.
2. Thread the screws through the holes on the belt clip.
3. Screw the belt clip back onto the radio body.

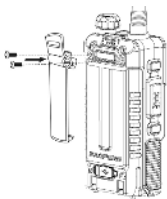



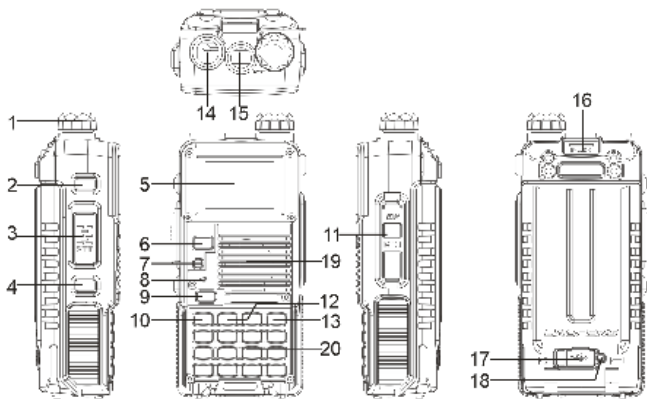

Installing Additional Speaker/Microphone (Optional)

1. Pry open the rubber MIC-Headset jack cover.
2. Insert the Speaker/Microphone plug into the double jack.

Radio Overview











- 1. Power / Volume knob
- 2. SK1 key – FM radios/Emergency key
- 3. PTT key
- 4. SK2- Customizable key (Monitor key)
- 5. Color LCD
- 6. V/M-VFO/MR key
- 7. LED Status Indicator
- 8. MIC Input
- 9. A/B key
- 10.  Menu key
- 11. Accessory jack
- 12.  or  navigation keys
- 13.  Exit key
- 14. Antenna Input
- 15. GPS antenna
- 16. Battery release latch
- 17. Type-C charge port
- 18. Type-C charge indicator
- 19. Speaker
- 20. Keypad















Status Indications

The LED (#7 on Radio Overview) will help you to identify the current radio status.

LED Indication	Meaning
Constant Green	Receiving Signal
Constant Red	Transmitting signal
Flashes Green	Monitor mode/Scanning Receiving

LCD Icon Summary

	Battery Level Indicator: Shows battery status.
	DTMF Side Tone: Make sure you can hear the DTMF side tone from the radio speaker, set it to DT-ST, ANI-ST, or DT+ANI.
	Dual Watch Enabled: Indicates dual watch mode.
	VOX Enabled: Voice-activated transmit is on.
	Bluetooth Function: Bluetooth Function activated.
	GPS Enabled: GPS function is on.
	Keypad Lock Enabled: Keypad is locked.
	Zone: Shows the current zone selected.
	VFO Mode: Indicates manual frequency input mode.

	A Display: Upper section displays and emission level.
	B Display: Lower section displays and emission level.
	Squelch Indicator: Squelch open/close indicator.
	Transmit Power (High): High transmission power.
	Transmit Power (Medium): Medium transmission power.
	Transmit Power (Low): Low transmission power.
	DCS Enabled: DCS tones active.
	CTCSS Enabled: CTCSS tones active.
	Repeater Access (High): TX shifted higher in frequency than RX (VFO Mode).
	Repeater Access (Low): TX shifted lower in frequency than RX (VFO Mode).
	Reverse Function: Frequency reversal enabled.
	Talkaround Enabled: Transmission frequency equals receive frequency.
	Confidential Call: Confidential calling feature activated.
	Narrowband Enabled: Narrowband mode active.

Main keypad controls

V/M Mode Key

Switches between Frequency (VFO) Mode and Memory (MR) Mode. Press and hold to enter the SEARCH (Quick Channel Clone) function.

A/B Selection Key

Switches between A (upper) and B (lower) displays. Press and hold to toggle GPS on/off.

Menu Key

Activates the menu, selects options, and confirms parameters. Press and hold to quickly enter GPS mode

Up Key

Press and hold for more than 2 seconds to move the channel and frequency upwards rapidly. In SCAN mode, press to move the scanning upwards.

Down Key

Press and hold for more than 2 seconds to move the channel and frequency downwards rapidly. In SCAN mode, press to move the scanning downwards.



Exit Key

Press to exit the menu and functions. Press and hold to quickly turn the stopwatch function on or off.



Numeric Keypad

Use these keys to input information or make selections on the radio.

Key

When there is a frequency difference between reception and transmission, press the  key to activate the frequency reversal and talkaround functions. The BF-F8HP PRO features a keypad lock that locks out all keys except for the three side keys. To enable or disable the keypad lock, press and hold the  key for about two seconds.

Key

When listening to broadcast FM, a brief press will start scanning. Scanning will stop as soon as an active station is found, regardless of the scanner resume method. To enable the scanner, press and hold the  key for about two seconds. A short press of the  key will open the DTMF sequence menu, where you can manually enter a DTMF string and transmit it using the **PTT**. This option is only active if *Menu > Radio Setting > DTMF Typing* is enabled.

[0] Key

Press and hold this key to activate the NOAA weather forecast reception function.

[1] Key

Press and hold this key to display the BF-F8HP PRO's current battery voltage.

[2] Key

Press and hold this key to change the BF-F8HP PRO's MR Display Mode (Name, Frequency, Channel Number).

[3] Key

Press and hold this key to change the BF-F8HP PRO's transmit power level (low, medium, high).

Basic Operations

Power On/Off the Radio

Turning the Unit On

To turn the unit on, rotate the Volume/Power knob clockwise until you hear a "click." If the radio powers on correctly, you will hear a double beep after about one second, and the display will show a message or flash the LCD, depending on the settings, for about one second. Then it will display a frequency or channel. If the voice prompt is enabled, it will announce "frequency mode" or "channel mode."

Turning the Unit Off

To turn the unit off, rotate the Volume/Power knob counterclockwise all the way until you hear a "click." The unit is now off.

Adjusting the volume

Increasing Volume

Turn the Volume/Power knob clockwise.

Decreasing Volume

Turn the Volume/Power knob counterclockwise. Be careful not to turn it too far, as you may inadvertently turn the radio off.

*Using the monitor function, enabled from the **VOX/Monitor** key below the **PTT**, you can easily adjust the volume by adjusting it to the un-squelched static.*

Main Band/Sub Band Switch

In standby mode, press the **A/B** key to switch between the main frequency band and the sub frequency bands. The highlighted frequency band is the main band, and the dimmed frequency band is the sub band.

VFO/Channel Switch

Press the **V/M** key to switch between VFO and channel display.

- In channel mode (MR), the channel number will be displayed.
- In frequency mode (VFO), the **VFO** will be displayed.

Frequency (VFO) mode

In Frequency (VFO) mode, you can navigate up and down the band using the **▲** or **▼** keys. Each press will change the frequency according to the set frequency step. You can also input frequencies directly on the numeric keypad with kilohertz accuracy.

Example (using a 12.5 kHz frequency step) Entering the frequency 436.61250 MHz on display A:

1. In standby mode, press the **V/M** key to switch to Frequency (VFO) mode.
2. Enter **[4][3][6][6][1][2][5][0]** on the numeric keypad.



WARNING: Just because you can program a channel does not mean you're authorized to use that frequency. Transmitting on unauthorized frequencies is illegal. However, it is generally legal to listen. Check with your local regulatory body for applicable laws and regulations.

Channel (MR) mode and Channel selection

The radio has two modes: Frequency (VFO) mode and Channel (MR) mode. Channel (MR) mode is more practical for everyday use, while Frequency (VFO) mode is useful for field experimentation and on the fly monitoring.

In Channel (MR) mode, you can navigate up and down the channels using the ▲ or ▼ keys. To switch between VFO and Channel mode, press the **V/M** key.

- **Operation 1:** Press the ▲ or ▼ navigation key to select the channel.
- **Operation 2:** Input the channel numbers on the keypad. For example, to switch to channel 12, input **[0][1][2]**.

If the voice prompt function is enabled, the corresponding channel will be announced by voice.

Selecting a ZONE



A zone is a group of channels with similar properties. The radio supports up to 10 zones, with a maximum of 100 channels per zone.

Select Zone

Press the  Menu key and go to Menu > ZONE.

Use the ▲ or ▼ navigation key to select a zone, and then press the  Menu key to switch to the selected zone.

Add Zone

1. Press the  Menu key to enter the main menu.
2. Select "Zone."
3. Select "Add Zone."
4. Input the zone name using the keypad, press the  Delete key to correct mistakes. After editing, press the  Menu key to confirm and store.

Delete Zone

- Press the  Menu key to enter the main menu.
- Select "Zone."
- Select "Delete Zone."
- Use the ▲ or ▼ navigation key to select a zone and press the Menu key to delete the current zone.

Making a Call

Press the A/B key to switch the main channel if two channels are displayed. In standby mode, press the [V/M] key to switch between frequency (VFO) mode and channel (MR) mode.

- Channel Mode Call: Select a channel, hold down the **PTT** key to initiate a call, and speak into the microphone with a normal tone. The red LED will be on while making a call.
- Frequency Mode Call: Press the **V/M** key to switch to frequency mode, input the working frequency within the allowable range, and press and hold the **PTT** key to transmit. Speak into the microphone with a normal tone. The red LED will be on while making a call.
- Receiving a Call: Release the **PTT** key to allow active receiving. The green LED will be on while receiving a call.

To ensure the best reception volume, keep the microphone 2.5 cm to 5 cm away from your mouth during transmission.

Emergency Alert

The Emergency Alert feature signals your group members for help. To activate it, press and hold the **SK1** key for 3 seconds. The radio will emit a loud siren sound, and the flashlight will flash. Press the **SK1** key again to exit the emergency alert function. Press the **SK1** (FM radios/ Emergency) key to exit the emergency alert function.

WARNING: Use the Emergency Alert feature only in actual emergencies.

FM Radio (FM)

The frequency range for listening to the radio is 65-108 MHz. When listening to broadcast FM, press the key to switch between the 65-75 MHz and 76-108 MHz bands.

1. In frequency or channel mode, press the **SK1** key to turn on the radio.
2. Select the desired radio frequency with the ▲ or ▼ keys or input the frequency. Press the  key to automatically search for a radio station.
3. Press the **SK1** key to exit FM radio.

While listening to the radio, the frequency or channel of the A/B receiving signal will automatically switch to frequency or channel mode for normal transmitting and receiving. When the signal disappears, the radio will switch back to FM radio mode.

Monitor

In standby mode, press and hold the **SK2** key to enter Monitor mode. This function allows you to monitor weak signals. Release the **SK2** key to turn off the monitor mode and it will return to standby mode.

*If no signal is present, pressing the **SK2** key will emit noise.*

Keypad lock

The radio features a keypad lock that locks out all keys except for the three side keys. To enable or disable the keypad lock, press and hold the  key for about two seconds. You can also set the radio to automatically lock the keypad after ten seconds via the menu.

Frequency reversal and talkaround

When there is a frequency difference between the receiving frequency and the transmitting frequency, the radio operates in relay mode. A short press of the  key enables the reverse function. To listen to the

repeater's input frequency, press the key momentarily to reverse the transmit and receive frequencies. The channel attribute bar will display this **R** change. Press the **[*no]** key again to switch to talkaround mode, where the receiving frequency equals the transmitting frequency. The channel attribute bar will display this mode **T**.

TX Repeaters Tone Burst

Press the **PTT + SK2** key to send a repeater tone burst (Select the tone burst via: *Menu > Radio Setting > Tone Burst*). This function is useful for communications through repeaters. You can send a tone burst without unlocking your radio if the keypad lock is enabled. You should first check to see if the Tone Burst is required to access the repeater before using.

One Touch Frequency Search

- The radio will act as a receiver. Press and hold the **V/M** key; the screen will display "SEARCH SEARCH..."
- If the transmitter continues to transmit and the unit receives an effective frequency (the strongest and most stable signal), the received frequency will be displayed. If there is a CTCSS or DCS code, it will be displayed; if not, "NONE" will be displayed.
- You can press the **[#]** key to save the search frequency and CTCSS or DCS code to a channel.

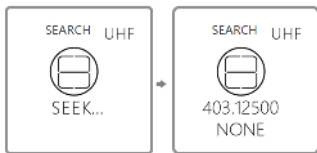

*During frequency search, press the **[#]** key on the radio to switch between UHF and VHF bands.*

Weather Radio/Scan Weather Channel

Your radio has a NOAA Weather Radio function to receive weather reports and a NOAA Weather Scan function to scan all 10 NOAA Weather Radio channels.

1. To turn on NOAA Weather Scan, press and hold the **[0]** key for 3 seconds. The  icon will appear, and the radio will enter Weather band mode.
2. Press and hold the **[# 2]** key for 3 seconds to start scanning all 10 channels. The scan will stop on active channels. Press and hold the **[# 2]** key for 3 seconds during scanning to stop the scan.
3. After stopping the scan, manually select a weather channel by pressing the **▲** or **▼** key.
4. To exit Weather Radio broadcast mode, press the **[5]** key or **PTT** key

Weather Channel Frequencies and Numbers

Channel Number	RX Frequency MHz	Channel Number	RX Frequency MHz
CH-01	162.550	CH-06	162.500
CH-02	162.400	CH-07	162.525
CH-03	162.475	CH-08	161.650
CH-04	162.425	CH-09	161.775
CH-05	162.450	CH-10	163.275

Weather Channels Wx 1 through 10 are receive-only channels for NOAA and Canadian weather broadcasts. You cannot transmit on these channels.

Stopwatch timer

In standby mode, press and hold the  key to display the stopwatch. To start counting, press the **MENU** key. Press the **MENU** key again to restart counting.





To exit the function, stop the counting first, then press the **EXIT** key.



Advanced Features

Scanner

The radio features a built-in scanner for VHF and UHF bands. In Frequency (VFO) mode, it scans in steps according to your set frequency step. In Channel (MR) mode, it scans your channels.

To enable the scanner, press and hold the  key for about two seconds. You can change the scanning direction with the  or  keys. Press and hold the  key again to exit scanning mode.

Frequency Range Scanning

In frequency mode, you can set the frequency sweep range precisely by inputting the start and end values of the sweep frequency through the keyboard. For VFO frequency range settings, set *Menu > Scan > Freq Range*.

- Enter **144146** to scan in the range of 144.000-146.000 MHz
- Enter **430440** to scan in the range of 430.000-440.000 MHz

Scan modes

The scanner can operate in three modes: Time, Carrier, or Search.

Time Operation (TO)

The scanner stops when it detects a signal and resumes scanning after a preset timeout.

Carrier Operation (CO)

The scanner stops when it detects a signal and resumes scanning after the signal disappears.

Search Operation (SE)





The scanner stops when it detects a signal. To resume scanning, press and hold the key again.

For scan mode settings, set *Menu > Scan > Scan Mode*.





Scan Sub-Code

To search for a CTCSS or DCS code (An active receiving signal must be present to work):

CTCSS Code

1. In VFO mode, enter a known frequency, such as 144.525.
2. Press the  key to enter *Menu > Scan > Scan SubCode*.
3. Select **CTCSS** using the ▲ or ▼ keys.
4. Press the  key to enter the CTCSS code scanning mode. The scanner will stop on a valid CTCSS code, and the speaker will turn on.
5. Press the  key to store the scanned CTCSS code and exit the scan. The  icon will be displayed on the top line of the screen. Press and hold the **PTT** key to make a callback.





DCS Code

1. In VFO mode, enter a known frequency, such as 144.525.
2. Press the  key to enter *Menu > Scan > Scan Sub-Code*.
3. Select DCS using the ▲ or ▼ keys.
4. Press the  key to enter the DCS code scanning mode. The scanner will stop on a valid DCS code, and the speaker will turn on.
5. Press the  key to store the scanned DCS code and exit the scan. The  icon will be displayed on the top line of the screen. Press and hold the **PTT** key to make a callback.

Sub-Code scan storage

In MR or VFO mode, the scanned CTCSS/DCS code can be stored as only TX, only RX, or both TX and RX codes, replacing the current channel or frequency mode's settings.

To save the settings of the scanned CTCSS/DCS code:

1. Press the  key to enter *Menu > Scan > Scan Memory*.
2. Enter the Scan Memory setting and use the  or  keys to select:
 - All:** Stores the scanned code as both RX and TX codes.
 - Receive:** Stores the scanned code as the RX code only.
 - Transmit:** Stores the scanned code as the TX code only.
3. Press the  key to save the settings and return to the previous menu.

This feature is used with the Scan Sub-code function detailed above.

Dual Watch / Single Watch

In certain situations, being able to monitor two channels at once can be very useful. This can be achieved in two ways:



Dual Watch



One receiver rapidly checks between two frequencies.

Dual Receive (Dual VFO)

A radio equipped with two receivers monitors two frequencies simultaneously.

Your radio supports Dual Watch functionality with a single receiver, allowing you to lock the transmit frequency to one of the two monitored channels. To enable or disable Dual Watch mode:

1. Press the  key to enter the main menu.
2. Enter **[3]** on the numeric keypad to go to Radio Settings.
3. Press the  key to confirm and enter **[14]** on the numeric keypad to access Dual Watch.
4. Press the  key to select.





5. Use the ▲ or ▼ keys to turn Dual Watch on or off.
6. Press the  key to confirm.
7. Press  to return to the previous menu.

When Dual Watch is enabled, the icon  will be displayed on the top line of the screen. To disable Dual Watch, repeat the above steps and select "Off." The icon will disappear.





Enabling or Disabling Single Watch Mode

The Single Watch menu option (15) only appears if Dual Watch is disabled.

Disable Dual Watch Mode

1. Press the  key to enter the main menu.
2. Enter [3] on the numeric keypad to go to Radio Settings.
3. Press the  key to confirm and enter 14 on the numeric keypad to access Dual Watch.
4. Press the  key to select.
5. Use the ▲ or ▼ keys to turn Dual Watch off.
6. Press the  key to confirm.
7. Press  to return to the previous menu.

Enable Single Watch Mode

1. Press the  key to enter the main menu.
2. Enter [3] on the numeric keypad to go to Radio Settings.
3. Press the  key to confirm and enter 15 on the numeric keypad to access Single Watch.
4. Press the  key to select.
5. Use the ▲ or ▼ keys to turn Single Watch on or off.
6. Press the  key to confirm.
7. Press  to return to the previous menu.

Using Single Watch Mode

When Single Watch mode is enabled, the radio will use the full screen to display all relevant information for a single channel, including: *Channel Name, Zone, Frequency*

This provides a clear and comprehensive view of your selected channel, making it easier to monitor and manage your communications.

Manual Programming (Channels Memory)

Memory channels store commonly used frequencies for easy retrieval. The radio supports up to 10 zones with a maximum of 100 channels per zone. Each channel can store receive and transmit frequencies, transmit power, group signaling information, bandwidth, ANI/PTT-ID settings, and a twelve-character alphanumeric identifier or channel name.

Frequency Mode vs. Channel Mode

In standby mode, press the **V/M** key to switch between Frequency (VFO) mode and Channel (MR) mode. These two modes serve different purposes and can often be confused.

Frequency Mode (VFO)

This mode is used for temporary frequency assignments, such as testing frequencies or quick field programming when permitted. It allows for more flexibility in setting and adjusting frequencies on the fly.

Channel Mode (MR)

This mode is used for selecting preprogrammed channels. It is ideal for regular use, as it provides quick and easy access to commonly used channels that have been saved in the radio's memory.

By understanding the distinct functions of each mode, you can effectively utilize your radio for various communication needs.



























Ex 1. Programming a Channel Repeater Offset with CTCSS Tone from VFO Mode (Using Offset Menu)

New memory in Channel 10:

RX = 432.55000 MHz

TX = 437.55000 MHz (This is a (+ 5) Offset)

TX CTCSS tone 123.0

1. Press the  key to switch between menus.
2. Press **V/M** key to set the radio to VFO mode, and the VFO icon is displayed.
3. Enter RX frequency (Ex. 43255000)
Enter RX frequency (Ex. 432.55000)
4.  [5]  [1] [5]  [1] [0] 
Deletes Prior Data in channel (Ex. 10)
5.  [5]  [4]  123.0 
Selects desired RX encode tone (Ex 123 CTCSS)
6.  [5]  [6]  123.0 
Selects desired TX encode tone (Ex 123 CTCSS)
7.  [5]  [1] [2]  [0] [0] [5] [0] [0] 
Enter the Offset frequency (Ex. 5.00MHz)
8.  [6]  [1][3]  [Plus] 
Select the Offset direction (Ex. plus Offset)
9.  [6]  [1][4]  [1][0] 
Enter the same channel (Ex 10)
-->> 
Channel has been added
10. Press **V/M** key to return to the MR mode and the channel number will reappear.



























Ex 2. Programming a Channel Repeater Offset with CTCSS Tone from MR Mode (Using Direct Frequency Entry)

New memory in Channel 10:

RX = 432.55000 MHz

TX = 437.55000 MHz (This is a (+ 5) Offset)

TX CTCSS tone 123.0



















1. Press the  key to switch between menus.
2. Press **V/M** key to set the radio to MR mode, and the VFO icon is not displayed.
3. Enter RX frequency (Ex. 43255000)
Enter RX frequency (Ex. 43255000)
4.  [5]  [1][7]  [1][0] 
Deletes Prior Data in channel (Ex. 10)
5.  [5]  [6]  123.0 
Selects desired RX encode tone (Ex 123 CTCSS)
6.  [5]  [8]  123.0 
Selects desired TX encode tone (Ex 123 CTCSS)
7.  [5]  [2]  43255000 
Enter RX frequency (Ex. 432.55000)
8.  [5]  [3]  43755000 
Enter TX frequency (Ex. 437.55000)
9.  [6]  [1][6]  [1][0] 
Enter the same channel (Ex 10)
-->> 
Channel has been added
10. Return to the MR mode and the channel number will reappear.

Ex 3. Programming a Simplex Channel with CTCSS Tone from VFO Mode

New memory in Channel 10:

RX/TX = 432.55000 MHz

TX CTCSS tone 123.0



























1. Press the  key to switch between menus.
2. Press **V/M** key to set the radio to VFO mode, and the VFO icon is displayed.
3. Enter RX frequency (Ex. 43255000)
Enter RX frequency (Ex. 432.55000)
4.  [5]  [1][5]  [1][0] 
Deletes Prior Data in channel (Ex. 10)
5.  [5]  [4]  123.0 
Selects desired RX encode tone (Ex 123 CTCSS)
6.  [5]  [6]  123.0 
Selects desired TX encode tone (Ex 123 CTCSS)
7.  [6]  [1][4]  [1][0] 
Enter the same channel (Ex 10)
-->> 
Channel has been added
8. Press **V/M** key to return to the MR mode and the channel number will reappear.

Ex 4. Programming a Simplex Channel with CTCSS Tone from MR Mode

New memory in Channel 10:







RX/TX = 432.55000 MHz

TX CTCSS tone 123.0

1. Press the  key to switch between menus.
2. Press **V/M** key to set the radio to MR mode, and the VFO icon is not displayed.
3. Enter RX frequency (Ex. 43255000)
Enter RX frequency (Ex. 43255000)
4.  [5]  [1][7]  [1][0] 
Deletes Prior Data in channel (Ex. 10)
5.  [5]  [6]  123.0 
Selects desired RX encode tone (Ex 123 CTCSS)
6.  [5]  [8]  123.0 
Selects desired TX encode tone (Ex 123 CTCSS)
7.  [5]  [2]  43255000 
Enter RX frequency (Ex. 432.55000)
8.  [5]  [3]  43255000 
Enter TX frequency (Ex. 432.55000)
9.  [6]  [1][6]  [1][0] 
Enter the same channel (Ex 10)
-->> 
Channel has been added
10. Return to the MR mode and the channel number will reappear.

VFO Repeaters Programming

The following instructions assume you know the transmit and receive frequencies your repeater uses and that you are authorized to use it.

1. Press the **V/M** key to set the transceiver to VFO mode. The VFO icon will be displayed on the right.
2. Use the numeric keypad to enter the repeater's output (your receive) frequency.
3. Press  [5]  [1][2] to set the Offset frequency.
4. Use the numeric keypad to enter the specified frequency Offset.
5. Press the key to confirm and save.
6. Press  [5]  [1][3] to set the Offset direction.
7. Use the  or  keys to select plus (positive) or minus (negative) Offset.
8. Press the  key to confirm and save.
9. Optional steps:
 - Save to memory. Refer to the section titled "Manual Programming" for details.
 - Set up CTCSS. Refer to the section titled "CTCSS" for details.
10. Press the key to exit the menu. If everything went well, you should be able to make a test call through the repeater.

If you experience problems connecting to the repeater, check your settings and repeat the procedure. If you are still unable to make a connection, contact the person in charge of the radio system with your employer or your local amateur radio club.





GPS function

The GPS function includes optional features that require hardware support. The position system utilizes a DTMF calling application. For setting call codes, call names, and local IDs, refer to the section "Signaling Calls."



Ensure that the radios sending and receiving GPS location information operate on the same frequency or channel and are set to the main frequency band. In GPS mode, you can only view location information and cannot make normal calls. To use voice intercom, you must exit GPS mode.

You can set the system time, GPS on/off, time zone, and GPS mode through the position system menu. Press and hold the  key to view, share, and request location information.



GPS On/Off Settings

1. Menu:  + 4 +  + 1
2. Press the  key to select whether to turn GPS on or off.
3. **Alternatively** press and hold the **A/B** key to toggle GPS on or off.
 - After turning on the position system, the screen will display the GPS  icon.



Time Zone Settings

1. Menu:  + 4 +  + 2
2. Press the  key to select the correct time zone.

Speed Unit Settings

1. Menu:  + 4 +  + 3
2. Press the  key to select the speed unit (km/h, MPH, kn).



GPS Mode Settings

1. Menu:  + 4 +  + 4
2. Press the  key to select the GPS mode (Beidou, GPS, or GPS+Beidou).



Using GPS:

1. In standby mode, press and hold the  key to enter GPS mode and



display "My Location" as an information list.

2. Press the  key to switch between information list mode and electronic compass mode.
3. Press the  key to switch the information of the selected member. The current member sequence will be displayed at the top of the interface.

Find My Position

1. Press and hold the  key to enter GPS mode.
2. Use the  keys to switch to "My Position."
3. The GPS will be in receive mode and display "Acquiring..." The GPS icon on the right will be red, indicating that positioning has not been successful. *If "Acquiring..." is displayed for a long time, it is recommended to search for satellites in an open location.*
4. When positioning is successful, "Acquiring Successful" will be displayed, showing the current time, longitude, latitude, and altitude (N for north latitude, E for east longitude, H for height). The GPS icon on the right will turn green.
5. Press the  key to switch between the GPS position information interface and the GPS distance direction interface.

Share My Position Information (Send to Others)

1. After successfully acquiring the GPS position, press the  key to switch to the location information interface.
2. Press the  key to select the pre-programmed member sequence (01-20). The member sequence and name will be displayed on the first line. Select the member sequence labeled as "native."
3. Press the **PTT** key to share the current location information with group members.

Requesting Someone Else's Position



1. After successfully acquiring the GPS position, press the key to switch to the "My Location" information interface.
2. Press the ▲/▼ key to select the pre-programmed member sequence (01-20). The sequence and call name will be displayed on the first line. Select member sequences that are not marked as "native."
3. Press the [PTT] key to initiate a position request command to the target member.
 - Disable transmission while waiting for reception.
 - If the other party receives your request, they will reply with their location information.
 - The red center point represents your position, the flashing red dot within the circle represents the other person's position, and the bottom left corner shows the reference distance between the two radios.



Main Menu Functions

The menu function allows you to perform operations such as selecting ZONE, SCAN, Radio Settings, GPS, Program Channels, and Radio Information.

Basic use

To navigate the menus using the arrow keys:





1. Press the  key to enter the main menu.
2. Use the ▲ or ▼ keys to navigate between menu items.
3. After finding the desired menu item, press the  key to select it.
4. Use the ▲ or ▼ keys to navigate between the next set of menu items.
5. Once you find the desired menu item, press the  key to select it.

6. Use the ▲ or ▼ keys to select the desired parameter.
7. When you have selected the parameter to be set, press the  key to confirm your selection. This will save your setting and bring you back to the main menu.
8. To cancel your changes, press the  key, which will reset that menu item and exit the menu entirely.
9. To exit the menu at any time, press the **PTT** key.

Using short-cuts







As detailed in Appendix C: Menu Definitions, every menu item has a numerical value associated with it. These numbers can be used for direct access to any given menu item.

To navigate the menu using short-cuts:

1. Press the  key to enter the menu.
2. Use the numerical keypad to enter the number of the menu item.
3. Press the  key to enter the menu item.
4. To enter the desired parameter, you have two options: a) Use the arrow keys as described in the previous section. b) Use the numerical keypad to enter the numerical short-cut code.
5. To confirm your selection, press the  key. This will save your setting and bring you back to the main menu.
6. To cancel your changes, press the  key. This will reset that menu item and exit the menu entirely.
7. To exit the menu at any time, press the **PTT** key.

All further examples and procedures in this manual will use the numerical menu short-cuts.

Quick Access Short-Cuts:

-  +1: Quickly enter zones selection. Up to 10 zones can be stored, each storing 100 channels.
-  +2: Quickly enter the scanner settings to set the VFO scan range, scan recovery method, and CTCSS/DCS scan.
-  +3: Quickly enter the radio settings (overall walkie-talkie settings).
-  +4: Quickly enter the position system to set the system time, position on/off, time zone, and position mode.
-  +5: Quickly enter the program channel settings (current channel alias, frequency, power, bandwidth, display mode, channel memory, and channel delete).
-  +6: Quickly query radio information (Radio ID, Firmware version, Hardware version).

Appendix A — Troubleshooting Guide

Issue	Analysis	Solution
Cannot turn on the radio.	The battery may be installed improperly.	Remove and reattach the battery.
	The battery power may be depleted.	Recharge or replace the battery.
	The battery contacts may be dirty or damaged.	Clean the battery contacts or replace the battery.
Voice is weak or intermittent during receiving	The battery voltage may be low.	Recharge or replace the battery.
	The volume level may be low.	Increase the volume.
	The antenna may be loose or installed incorrectly.	Turn off the radio, then remove and reattach the antenna.
	The speaker may be blocked.	Clean the surface of the speaker.
Cannot communicate with other group members	The frequency or signaling type may be inconsistent with other members.	Verify that your TX/RX frequency and signaling type are correct.
	You may be too far away from other members.	Move closer to other members.

Hear unknown voices or noise	You may be interrupted by radios using the same frequency.	Change the frequency or adjust the squelch level.
	The radio may be set with no signaling in analog mode.	Change or set signaling for the current channel to avoid interference.
Too much noise and hiss, unable to hear anyone	You may be too far away from other members.	Move closer to other members.
	You may be in an unfavorable position (e.g., blocked by buildings or underground).	Move to an open and flat area, restart the radio, and try again.
	There may be external disturbances (e.g., electromagnetic interference).	Stay away from equipment that may cause interference.
Radio keeps transmitting	VOX may be turned on, or the headset is not properly installed.	Turn off the VOX function. Ensure the headset is properly installed.

If the above solutions do not resolve your issues, or if you have other queries, please contact your dealer for further technical support.

Appendix B — Technical Specifications

General

Channel Capacity	144 to 148 MHz, 222-225MHz, 420 to 450 MHz
Channel Spacing	16K0F3E/11K0F3E
Input Voltage	-16 dBm>1GHz, -16 dBm>1GHz
Battery Life: 5% TX, 5% RX, 90% Standby	Li-on: 15 hours @ 5 watts
Operating temperature	-10°C to 60°C
Antenna Impedance	50 Ω
Radio Dimensions	135mm X 61mm X 39mm (not including antenna)
Radio Weight	260 g (with Li-ON battery)

Transmitter

Frequency Range (TX)	144 to 148 MHz, 222-225MHz, 420 to 450 MHz
Modulation	16K0F3E/11K0F3E
Spurious Emission	-16 dBm>1GHz, -16 dBm>1GHz
FM noise	±2.5 ppm
Audio Distortion	≤5%
FM Hum & Noise	40 dB

Receiver

Frequency Range	88-108MHz, 108-136 MHz, 136-174 MHz, 220-260 MHz, 350-390 MHz, 400-520 MHz (Scan Receiver)
Sensitivity: 12 dB SINAD	-120 dBm
Adjacent Channel Selectivity	-60 dBm
Intermodulation and Rejection	-70 dBm
Rated Audio Power Output	0.75 Watts @ 16 Ω
Rated Audio Distortion	$\leq 5\%$

All specifications may be modified without prior notice or liability.

Appendix C — Shortcut Menu Operations



Menu	Name	Setting	Description
Zone	Zone Select	ZONE 1~ ZONE 10	Enter the zone list, access the zone, and select a zone.
	Add Zone	Alpha Numeric Entry	Create a new Zone and Provide a Zone Name
	Delete Zone	ZONE 1~ ZONE 10	Enter the zone list and delete a zone
	Edit Zone	Alpha Numeric Entry	Edit the Selected Zone's Name
Scan	Freq Range		Input VFO range lower and upper frequency
	Scan Mode	Time	Time: Scanning will resume after a fixed time has passed.
		Carrier	Carrier: Scanning will resume after the signal disappears.
Search		Search: Scanning stops on active signal must be manually re-started.	

Scan	Scan SubCode	CTCSS	Search for CTCSS Tone (Range 67-254.1, a total of 50 tones).
		DCS	Search for DCS Code (Range 023N-754I, a total of 210 tones).
	Scan Memory	All	Scanned CTCDD/DCS are saved to both RX and TX locations (default is all, RX and TX are the same).
		Receive	Save only in RX CTCSS/DCS.
		Transmit	Save only in TX CTCSS/DCS.
	Radio Setting	Step	2.5-100K
Squelch		Off, Level 1-Level 5	Squelch silences the receiver when there is no signal. Setting squelch to 0 will open the squelch entirely.

Radio Setting	Power Save	Off	Turn off power save. Higher battery consumption, shorter standby time.
		On	Turn on power save. More power-efficient but you may miss the first few syllables before receiver turns on.
	VOX Switch	Off	Turn Off the radio's VOX.
		On	Turn on the radio's VOX.
	VOX Level	Level 1-Level 9	When enabled, it is not necessary to press the PTT button on the transceiver as it will transmit on Voice Activation. Adjust the gain level to the appropriate sensitivity to allow transmission and minimize noise pickup activation.

Radio Setting	VOX Delay	0.5.....2.0s	When VOX is enabled, set the VOX delay to extend the transmission time and prevent it from stopping too early. Adjustable in 0.1-second increments, offering a total of 16 settings.
	TOT	Off	Allows continuous transmission with no time limit.
		15;30;45...180	Sets the maximum transmission time while holding down the PTT key.
	TOA	Off	Disables the TOA function.
		1.....10 seconds	Activates the TOA function. Adjustable in 1-second increments.
	Voice Prompts	Off	Disables voice prompts.
		On	Activates voice prompts.

Radio Setting	Roger Tone	Off	Disables the Roger function. Releasing the PTT key will not produce Roger audio.
		On	Activates the Roger function. Sends an end-of-transmission tone to indicate that the transmission has ended.
	Key Beep	Off	Disables key confirmation tone.
		On	Activates key confirmation tone, providing audible feedback for key presses.
	Backlight	Always On	Keeps the backlight on continuously.
		5.....20.30.60	Sets the backlight off time after a period of no operation.



Radio Setting	Power on Display	Picture	Show preset picture when the radio powers on.
		Battery Voltage	Display battery voltage when the radio powers on.
		Station ID	Display call sign when the radio powers on.
	Dual Watch	Off	Disables dual watch and dual receive. <i>NOTE: The single watch menu will be automatically added.</i>
		On	Monitors [A] and [B] simultaneously. The display with the most recent activity ([A] or [B]) becomes the selected display.
	Auto Lock	Off	Disables automatic keypad lock. Allows manual keypad lock (press and hold the  key to lock/unlock the keyboard.
		On	Locks the keypad if not used in 8 seconds. Pressing the  key for 2 seconds will unlock the keypad.



Radio Setting	Alarm Mode	On Site Sound	Sounds alarm through your radio speaker only.
		Transmit Sound	Transmits a cycling tone over-the-air.
		Transmit Code	Transmits '119' (911 in reverse) followed by the ANI code over-the-air.
	Alarm Tone	Off	The radio speaker blocks the alarm sound.
		On	The radio speaker sounds an alarm.
	Radio ID	XXX	View the ANI ID, and if necessary, change the ANI ID.
	Display ANI	Off	Do not display ANI ID when DTMF decoding is correct.
		On	Display ANI ID when DTMF decoding is correct.

Radio Setting	DTMF Side Tone	Off	No DTMF side tones are heard.
		DT-ST	Side tones are heard only from manually keyed DTMF codes.
		ANI-ST	Side tones are heard only from automatically keyed DTMF codes.
		DT+ANI	All DTMF side tones are heard.
	PTT ID	Off	No ID is sent.
		BoT	The selected S-CODE is sent at the beginning.
		EoT	The selected S-CODE is sent at the end.
		BoT+EoT	The selected S-CODE is sent at both the beginning and end.
	PTT Code Delay	100-3000ms	Signal code sending delay (milliseconds).

Radio Setting	Tone Burst	1000Hz	The following configurations will transmit accordingly: PTT + SK2= Transmits 1000Hz Tone Burst
		1450Hz	PTT + SK2= Transmits 1450Hz Tone Burst
		1750Hz	PTT + SK2= Transmits 1750Hz Tone Burst
		2100Hz	PTT + SK2= Transmits 2100Hz Tone Burst
	Tail Squelch	Off	Disable squelch tail elimination.
		On	Enable squelch tail elimination to prevent any squelch tails from being heard.
	Menu Exit time	Off, 10-60S	After entering the menu, start the menu reset timer. If there are no panel keys, PTT keys, or menu-related programmable key operations before the timer overflows, the menu will exit.

Radio Setting	SK2 Function	FM Radio	Toggle FM radio on/off.
		Scan	Toggle scan on/off.
		Search	Toggle search on/off.
		VOX	Toggle VOX on/off.
		TX Power	Toggle Power Levels.
	Station ID		Enter a call sign, up to 7 letters.
	DTMF Typing	Off	Disable DTMF function.
		On	Enable Manual DTMF function. (Enter By Pressing #)
	Power on Time	3 seconds	Display shows for 3 seconds at power on.
		5 seconds	Display shows for 5 seconds at power on.
		10 seconds	Display shows for 10 seconds at power on.
	Reset	Reset only VFO	Reset the radio's VFO menu to factory defaults (no reset for Zone, MR, and scan settings).
		Reset All	Resets the radio to factory defaults, with some exceptions.

GPS	GPS Receiver	Off	Turns off the positioning system. Long press of the  key is ineffective.
		On	Turns on the positioning system. Press and hold the  key to enter GPS mode.
	Time Zone	-12 to 0 to + 12	Sets the time zone of the region.
	Speed Unit	Km/h	Kilometers per hour
		MPH	Miles per hour
		kn	Knots per hour
	GPS Mode	GPS	Only GPS.
		BDS	Only BeiDou.
		GPS+BDS	GPS and BeiDou adaptive.
Program Channel-Under Channel Mode	Channel Name	Channel 1	View and rename the current channel. Press the key to switch the input method, allowing the entry of letters, numbers, and symbols (up to 12 characters).

Program Channel-Under Channel Mode	Rx Frequency		View the current channel receiver frequency and allow changes. Input the RX frequency using the keypad, then press the  key to save.
	Tx Frequency		View the current channel transmitter frequency and allow changes. Input the TX frequency using the keypad, then press the  key to save.
	Transmit Power	High	Select HIGH transmitter power when in VFO/ Frequency mode.
		Medium	Select MEDIUM transmitter power when in VFO/ Frequency mode.
		Low	Select LOW transmitter power when in VFO/ Frequency mode.
	Bandwidth	Wide(25K)	Wideband (25 kHz bandwidth).
		Narrow (12.5K)	Narrowband (12.5 kHz bandwidth).

Program Channel-Under Channel Mode	Rx CTCSS	Off;67-254.1	Mutes the speaker of the transceiver in the absence of a specific and continuous sub-audible signal. If the station you are listening to does not transmit this specific and continuous signal, you will not hear anything. <i>Manually Type in Any CTCSS Tone to Use a Custom Non-standard CTCSS Tone.</i>
	Rx DCS	Off,023N-754I	Mutes the speaker of the transceiver in the absence of a specific low-level digital signal. If the station you are listening to does not transmit this specific signal, you will not hear anything.
	Tx CTCSS	Off;67-254.1	Transmits a specific and continuous sub-audible signal to unlock the squelch of a distant receiver. <i>Manually Type in Any CTCSS Tone to Use a Custom Non-standard CTCSS Tone.</i>

Program Channel-Under Channel Mode	Tx DCS	Off,023N-754I	Transmits a specific low-level digital signal to unlock the squelch of a distant receiver.
	Encryption	Off	Disables encrypted mode, making conversations not private.
		On	Activates encryption mode to ensure the privacy of your conversations. Note: <i>To use the encryption function, the other party's radio must also have encryption activated and be tuned to the same DCS code.</i>
	Signaling	1-20	Selects one of 20 DTMF codes. The DTMF codes are programmed with software and are up to 3 digits each.

Program Channel-Under Channel Mode	CH. Display Mode	Name	MR/Channel mode is displayed in NAME format. Note: NAME allows CPS programming or editing of the channel name.
		Under Channel Mode	MR/Channel mode is displayed in frequency format.
		Channels #	MR/Channel mode is displayed in channel number format.
	SP Mute	QT	The monitor feature is activated only when the radio receives the correct CTCSS/DCS.
		QT+DTMF	The monitor is activated when the radio receives the correct CTCSS/DCS and the correct DTMF code.
	Scan Add	Off	Disabled the current channel to join the scan group.
		On	Add the current channel to the scan group.

Program Channel-Under Channel Mode	Busy CH. Lockout	Off	The PTT button on the channel is always allowed.
		On	Disables the PTT button on a channel that is already in use. The transceiver will sound a beep tone and will not transmit if the PTT button is pressed when a channel is already in use.
	Channel Memory	CH001-CH100	Create new or modify existing channels (1 through 100) so they can be accessed from MR/Channel Mode.
	Channel Delete	CH001-CH100	Delete the programmed information from the specified channel (1 through 100) so it can be reprogrammed or left empty.
Program Channel-Under VFO Mode	Rx Frequency		View the current channel receiver frequency and allow changes. Input the RX frequency using the keypad, then press the  key to save.

Program Channel-Under VFO Mode	Transmit Power	High	Select HIGH transmitter power when in VFO/ Frequency mode.
		Medium	Select MEDIUM transmitter power when in VFO/ Frequency mode.
		Low	Select LOW transmitter power when in VFO/ Frequency mode.
	Bandwidth	Wide(25K)	Wideband (25 kHz bandwidth).
		Narrow (12.5K)	Narrowband (12.5 kHz bandwidth).
	Rx CTCSS	Off;67-254.1	Mutes the speaker of the transceiver in the absence of a specific and continuous sub-audible signal. If the station you are listening to does not transmit this specific and continuous signal, you will not hear anything. <i>Manually Type in Any CTCSS Tone to Use a Custom Non-standard CTCSS Tone.</i>

Program Channel-Under VFO Mode	Rx DCS	Off,023N-754I	Mutes the speaker of the transceiver in the absence of a specific low-level digital signal. If the station you are listening to does not transmit this specific signal, you will not hear anything.
	Tx CTCSS	Off;67-254.1	Transmits a specific and continuous sub-audible signal to unlock the squelch of a distant receiver. <i>Manually Type in Any CTCSS Tone to Use a Custom Non-standard CTCSS Tone.</i>
	Tx DCS	Off,023N-754I	Transmits a specific low-level digital signal to unlock the squelch of a distant receiver.

Program Channel-Under VFO Mode	Encryption	Off	Disables encrypted mode, making conversations not private.
		On	Activates encryption mode to ensure the privacy of your conversations. Note: To use the encryption function, the other party's radio must also have encryption activated and be tuned to the same DCS code.
	Signaling	1-20	Selects one of 20 DTMF codes. The DTMF codes are programmed with software and are up to 3 digits each.

Program Channel-Under VFO Mode	CH. Display Mode	Name	MR/Channel mode is displayed in NAME format. Note: NAME allows CPS programming or editing of the channel name.
		Frequency	MR/Channel mode is displayed in frequency format.
		Channels #	MR/Channel mode is displayed in channel number format.
	SP Mute CH. Display Mode	QT	The monitor feature is activated only when the radio receives the correct CTCSS/DCS.
		QT+DTMF	The monitor is activated when the radio receives the correct CTCSS/DCS and the correct DTMF code.

Program Channel- Under VFO Mode	Busy CH. Lockout	Off	The PTT button on the channel is always allowed.
		On	Disables the PTT button on a channel that is already in use. The transceiver will sound a beep tone and will not transmit if the PTT button is pressed when a channel is already in use.
	Offset		Specifies the difference between the TX and RX frequencies.
	Direction	None	TX = RX (simplex). Disables access to repeaters in VFO/ Frequency mode.
		Plus	TX will be shifted higher in frequency than RX.
		Minus	TX will be shifted lower in frequency than RX.

Program Channel-Under VFO Mode	Channel Memory	CH001-CH100	Create new or modify existing channels (1 through 100) so they can be accessed from MR/Channel Mode.
	Channel Delete	CH001-CH100	Delete the programmed information from the specified channel (1 through 100) so it can be reprogrammed or left empty.
Radio Info	Radio ID\Firmware\Hardware		Displays radio ID, firmware version, and hardware version to check the radio information.

Appendix D — DCS Table

DCS Code List

No.	Code	No.	Code	No.	Code	No.	Code	No.	Code
1	D023N	2	D025N	3	D026N	4	D031N	5	D032N
6	D036N	7	D043N	8	D047N	9	D051N	10	D053N
11	D054N	12	D065N	13	D071N	14	D072N	15	D073N
16	D074N	17	D114N	18	D115N	19	D116N	20	D122N
21	D125N	22	D131N	23	D132N	24	D134N	25	D143N
26	D145N	27	D152N	28	D155N	29	D156N	30	D162N
31	D165N	32	D172N	33	D174N	34	D205N	35	D212N
36	D223N	37	D225N	38	D226N	39	D243N	40	D244N
41	D245N	42	D246N	43	D251N	44	D252N	45	D255N
46	D261N	47	D263N	48	D265N	49	D266N	50	D271N
51	D274N	52	D306N	53	D311N	54	D315N	55	D325N
56	D331N	57	D332N	58	D343N	59	D346N	60	D351N
61	D356N	62	D364N	63	D365N	64	D371N	65	D411N
66	D412N	67	D413N	68	D423N	69	D431N	70	D432N
71	D445N	72	D446N	73	D452N	74	D454N	75	D455N
76	D462N	77	D464N	78	D465N	79	D466N	80	D503N
81	D506N	82	D516N	83	D523N	84	D526N	85	D532N
86	D546N	87	D565N	88	D606N	89	D612N	90	D624N
91	D627N	92	D631N	93	D632N	94	D645N	95	D654N
96	D662N	97	D664N	98	D703N	99	D712N	100	D723N

101	D731N	102	D732N	103	D734N	104	D743N	105	D754N
106	D023I	107	D025I	108	D026I	109	D031I	110	D032I
111	D036I	112	D043I	113	D047I	114	D051I	115	D053I
116	D054I	117	D065I	118	D071I	119	D072I	120	D073I
121	D074I	122	D114I	123	D115I	124	D116I	125	D122I
126	D125I	127	D131I	128	D132I	129	D134I	130	D143I
131	D145I	132	D152I	133	D155I	134	D156I	135	D162I
136	D165I	137	D172I	138	D174I	139	D205I	140	D212I
141	D223I	142	D225I	143	D226I	144	D243I	145	D244I
146	D245I	147	D246I	148	D251I	149	D252I	150	D255I
151	D261I	152	D263I	153	D265I	154	D266I	155	D271I
156	D274I	157	D306I	158	D311I	159	D315I	160	D325I
161	D331I	162	D332I	163	D343I	164	D346I	165	D351I
166	D356I	167	D364I	168	D365I	169	D371I	170	D411I
171	D412I	172	D413I	173	D423I	174	D431I	175	D432I
176	D445I	177	D446I	178	D452I	179	D454I	180	D455I
181	D462I	182	D464I	183	D465I	184	D466I	185	D503I
186	D506I	187	D516I	188	D523I	189	D526I	190	D532I
191	D546I	192	D565I	193	D606I	194	D612I	195	D624I
196	D627I	197	D631I	198	D632I	199	D645I	200	D654I
201	D662I	202	D664I	203	D703I	204	D712I	205	D723I
206	D731I	207	D732I	208	D734I	209	D743I	210	D754I

Appendix E — CTCSS Table

CTCSS CHART (Hz)

No.	Freq.	No.	Freq.	No.	Freq.	No.	Freq.	No.	Freq.
1	67.0	2	69.3	3	71.9	4	74.4	5	77.0
6	79.7	7	82.5	8	85.4	9	88.5	10	91.5
11	94.8	12	97.4	13	100	14	103.5	15	107.2
16	110.9	17	114.8	18	118.8	19	123.0	20	127.3
21	131.8	22	136.5	23	141.3	24	146.2	25	151.4
26	156.7	27	159.8	28	162.2	29	165.5	30	167.9
31	171.3	32	173.8	33	177.3	34	179.9	35	183.5
36	186.2	37	189.9	38	192.8	39	196.6	40	199.5
41	203.5	42	206.5	43	210.7	44	218.1	45	225.7
46	229.1	47	233.6	48	241.8	49	250.3	50	254.1

Disclaimer

While we strive for accuracy and completeness in the compilation of this handbook, we do not assume any responsibility for possible errors or omissions. As technology continually evolves, we reserve the right to change the design and specifications of the product without prior notice. No part of this handbook may be copied, modified, translated, or distributed in any form without prior written authorization from our department.



BTECH Radios

Made in China, Designed in South Dakota

www.baofengtech.com